

Lecture 6 – Supplement data

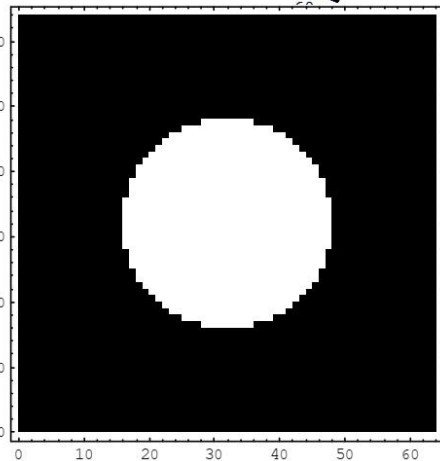

*Examples of Fourier transformations for lecture 6*

Lecture 6 – Supplement data

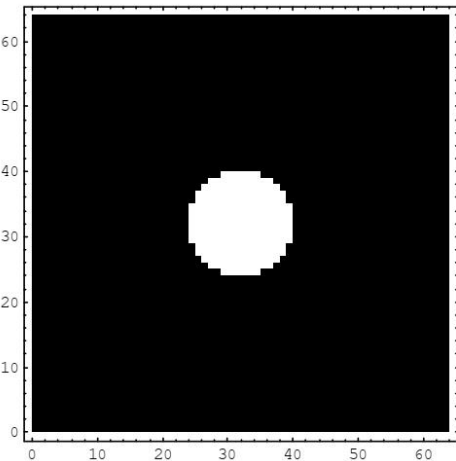
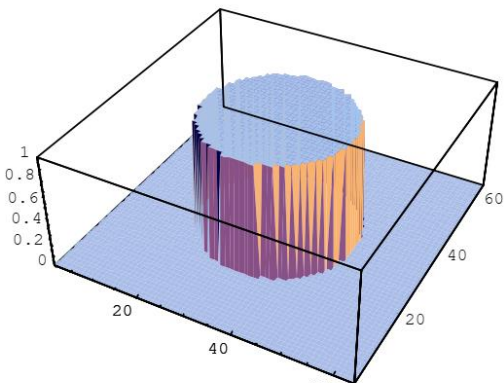
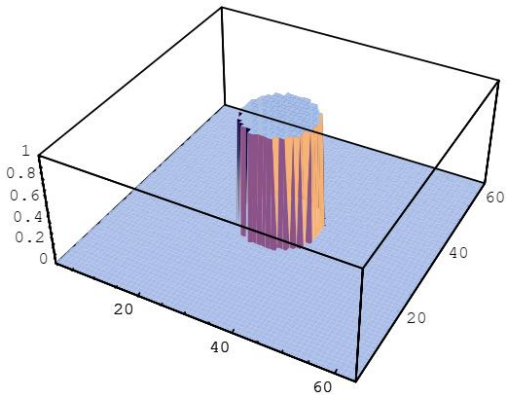
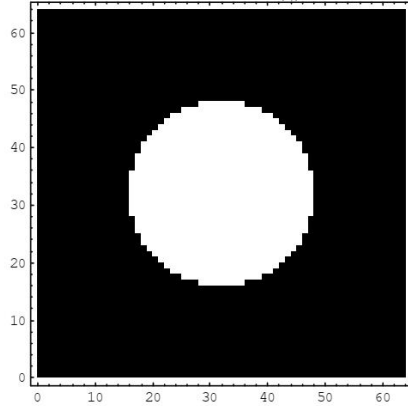
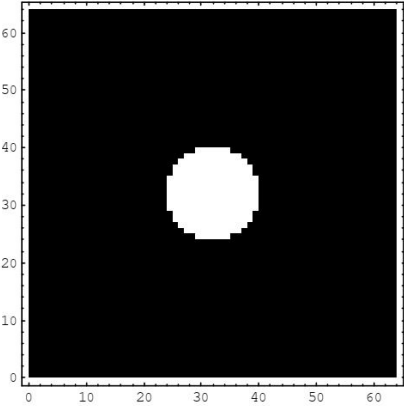
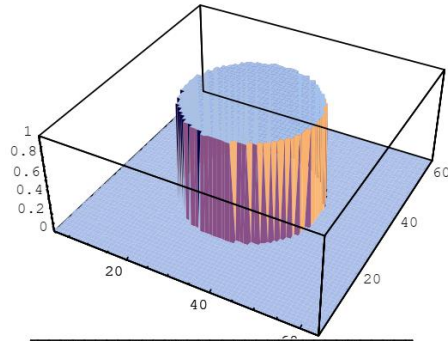
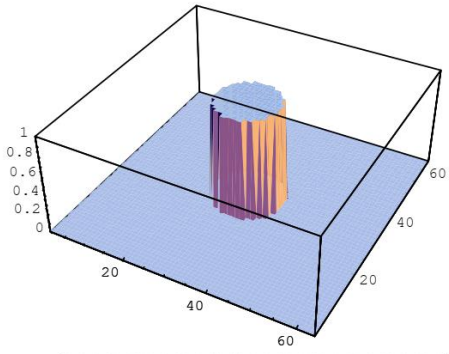
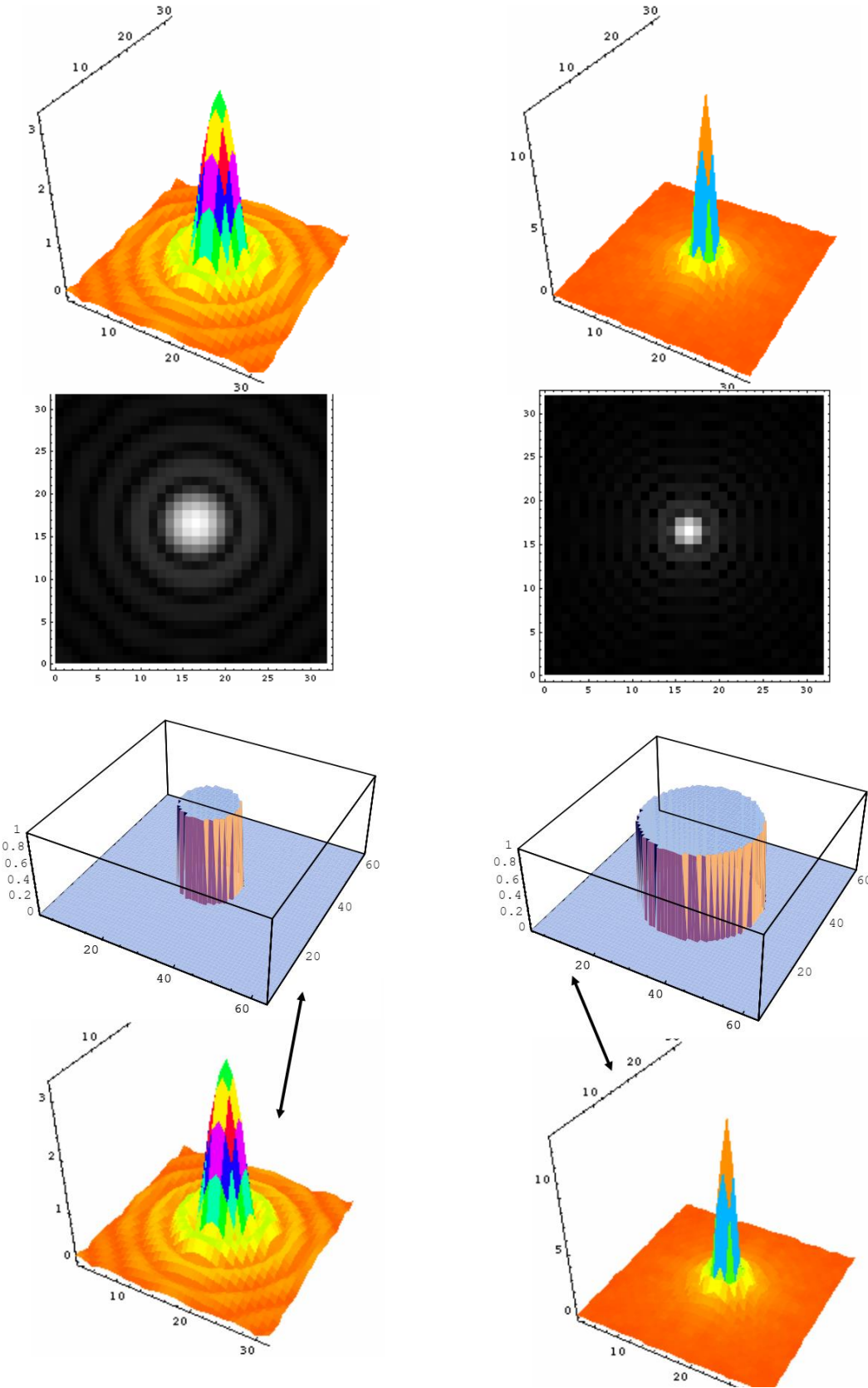

*Examples of Fourier transformations for lecture 6*

Lecture 6 – Supplement data

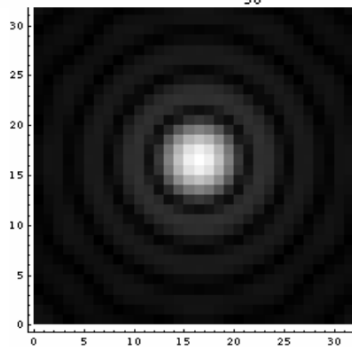
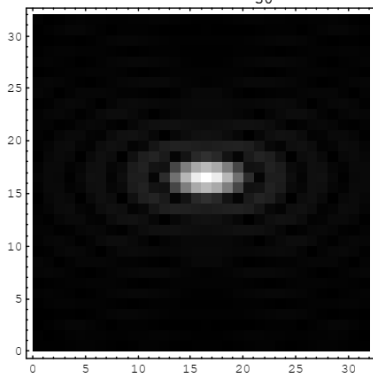
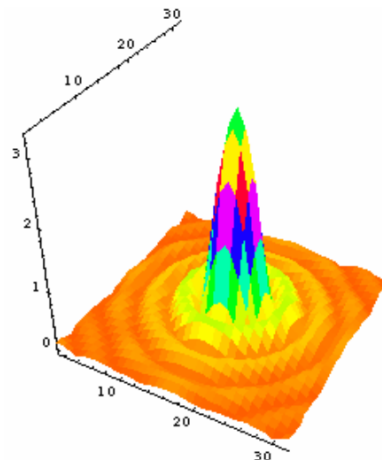
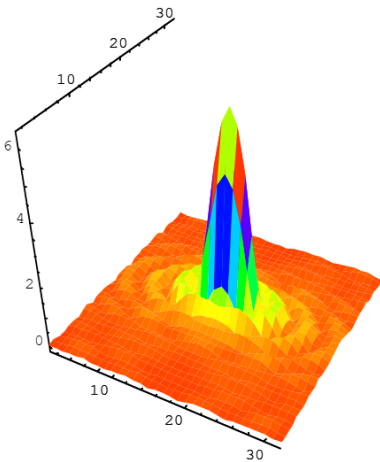
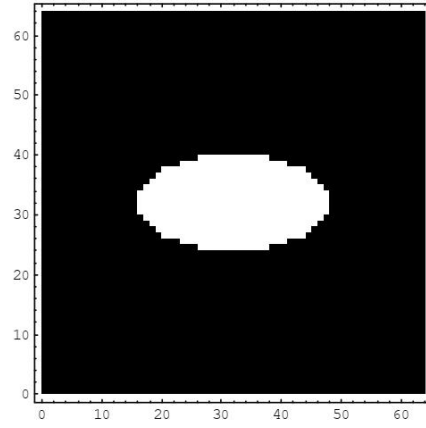
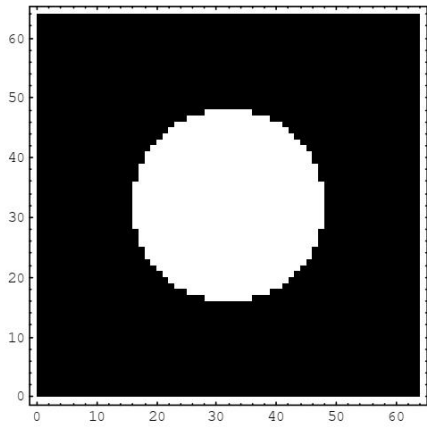
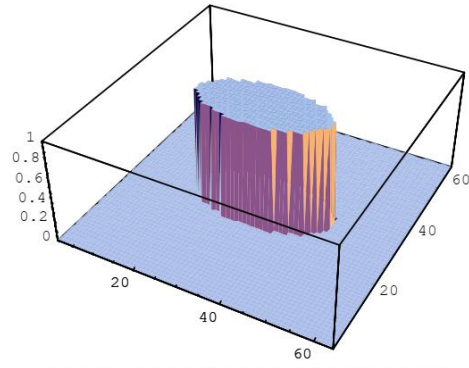
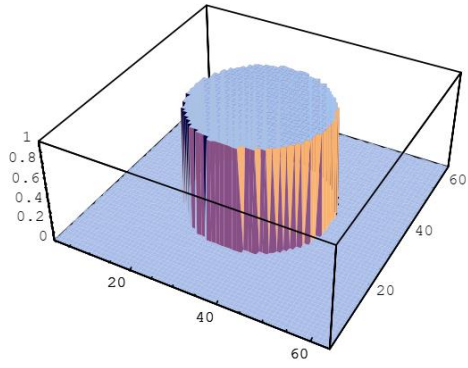

*Examples of Fourier transformations for lecture 6*

Lecture 6 – Supplement data

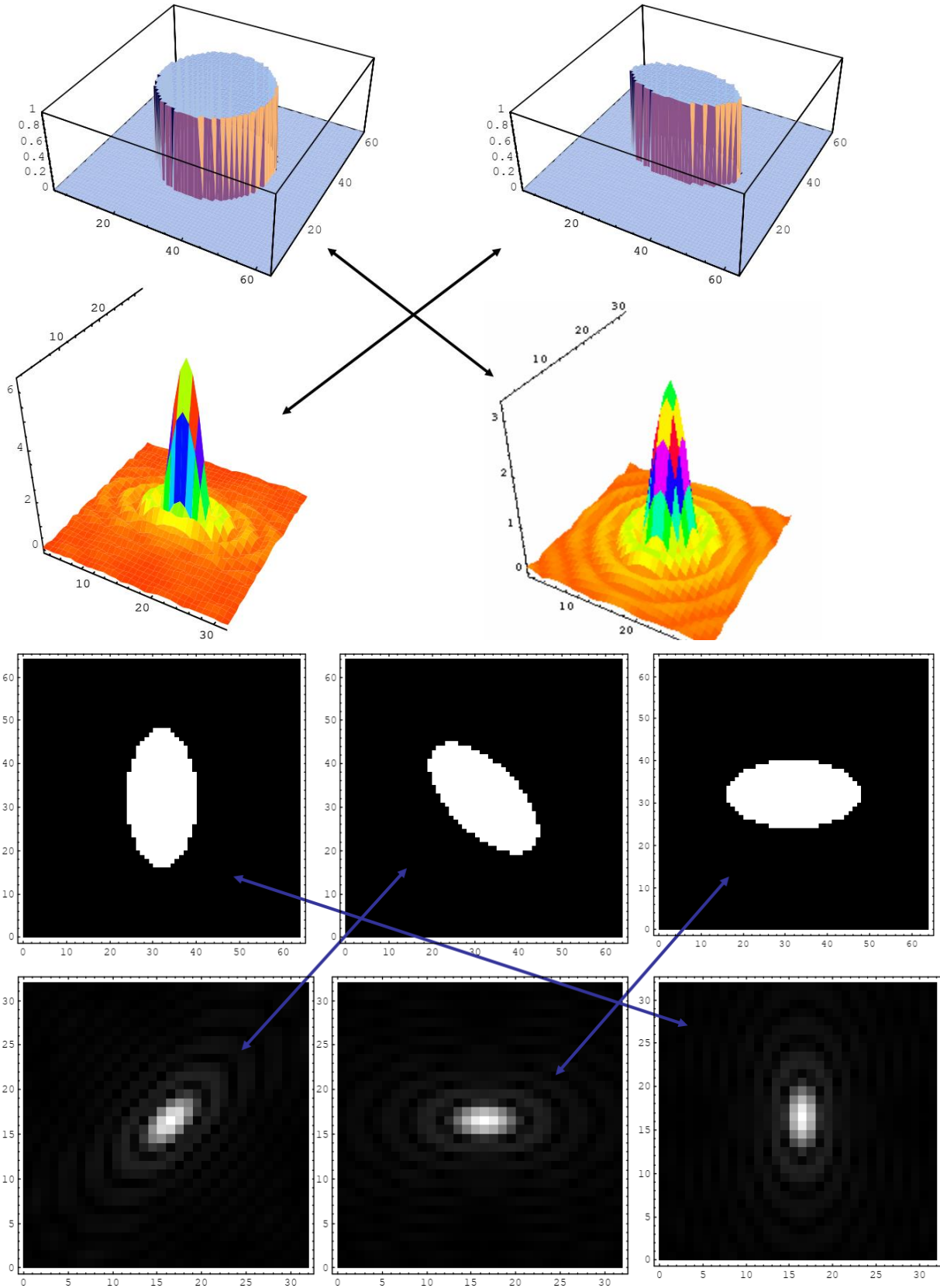

*Examples of Fourier transformations for lecture 6*

Lecture 6 – Supplement data

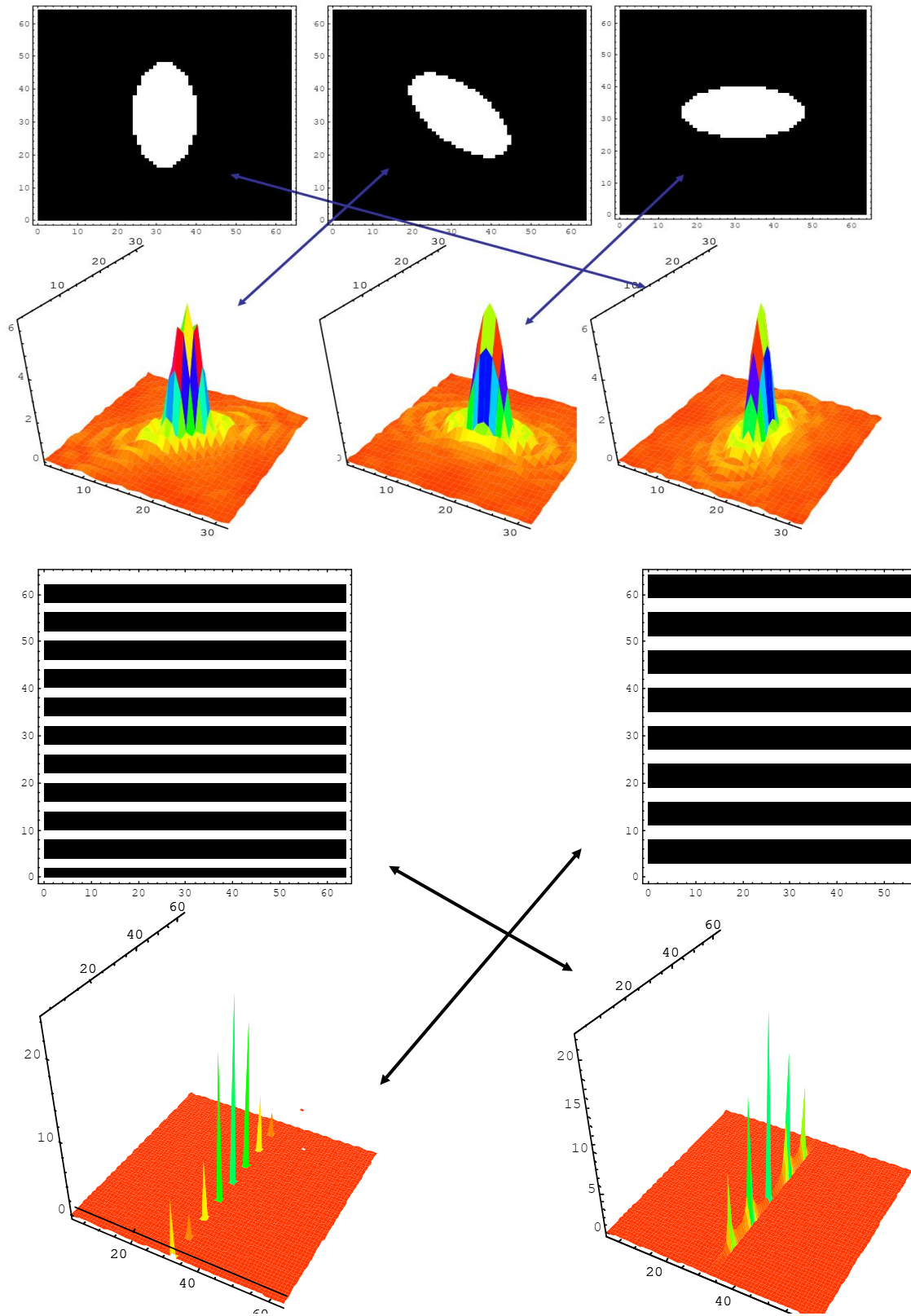

*Examples of Fourier transformations for lecture 6*

Lecture 6 – Supplement data

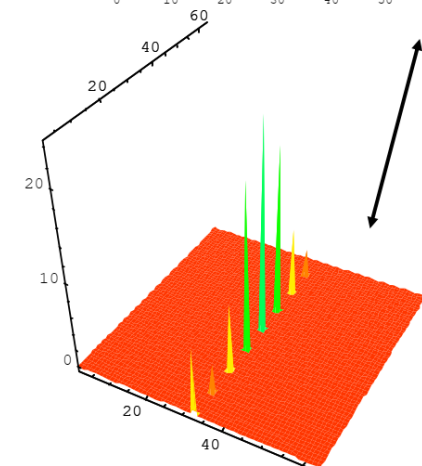
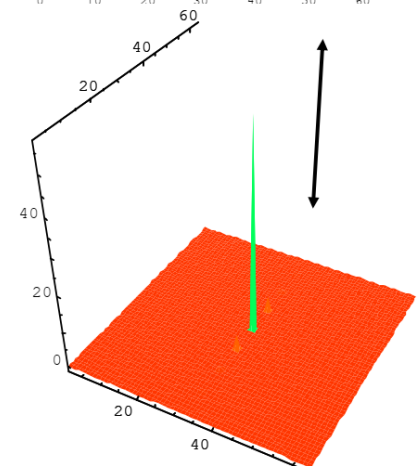
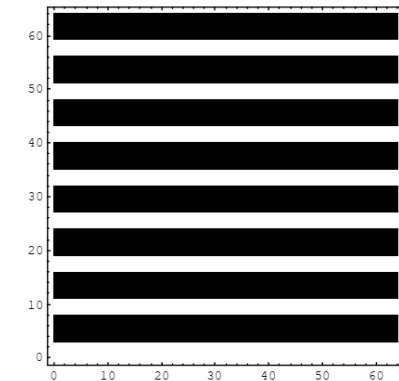
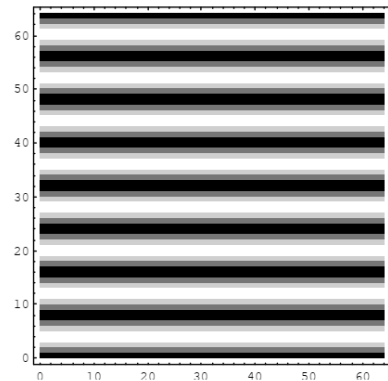
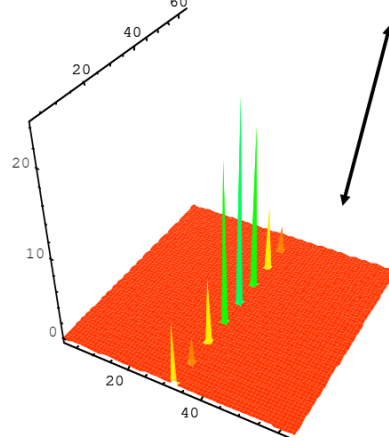
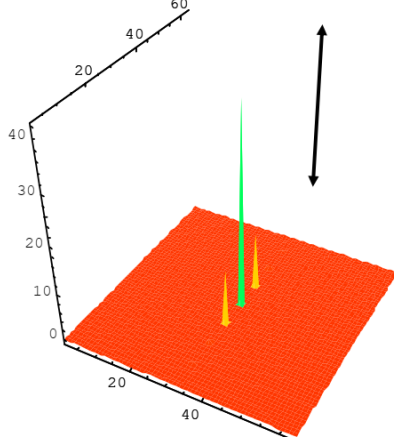
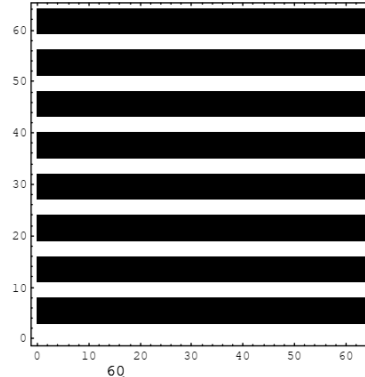
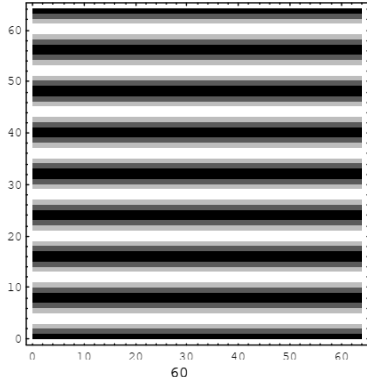

*Examples of Fourier transformations for lecture 6*

Lecture 6 – Supplement data

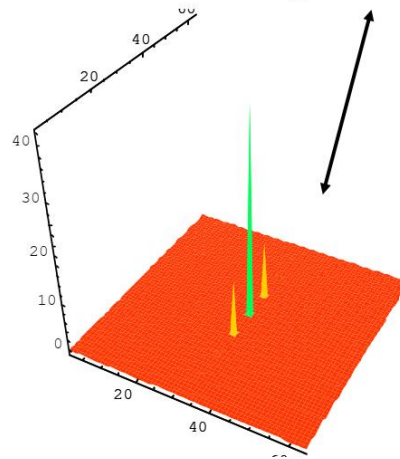
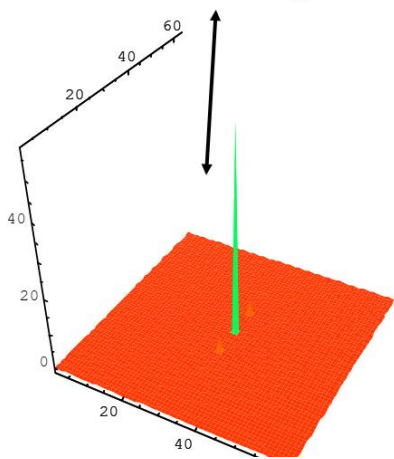
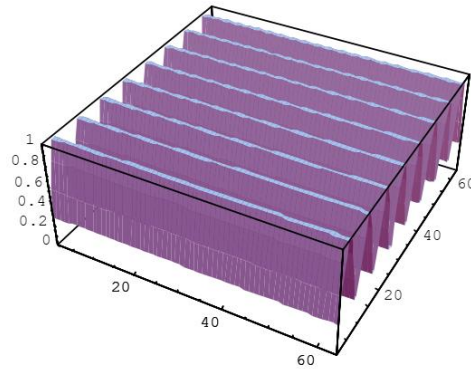
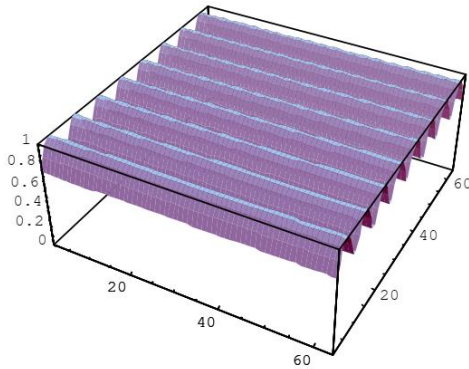
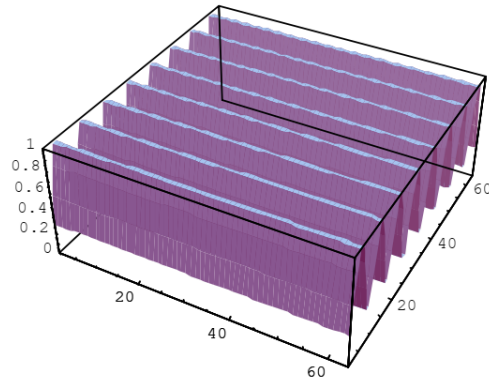
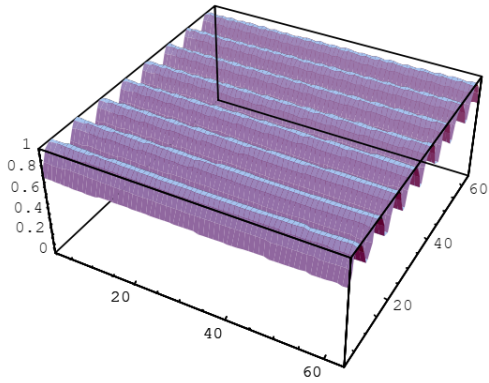
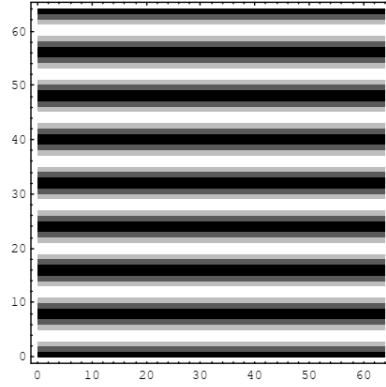
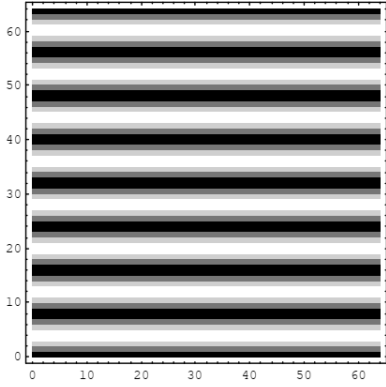

*Examples of Fourier transformations for lecture 6*

Lecture 6 – Supplement data

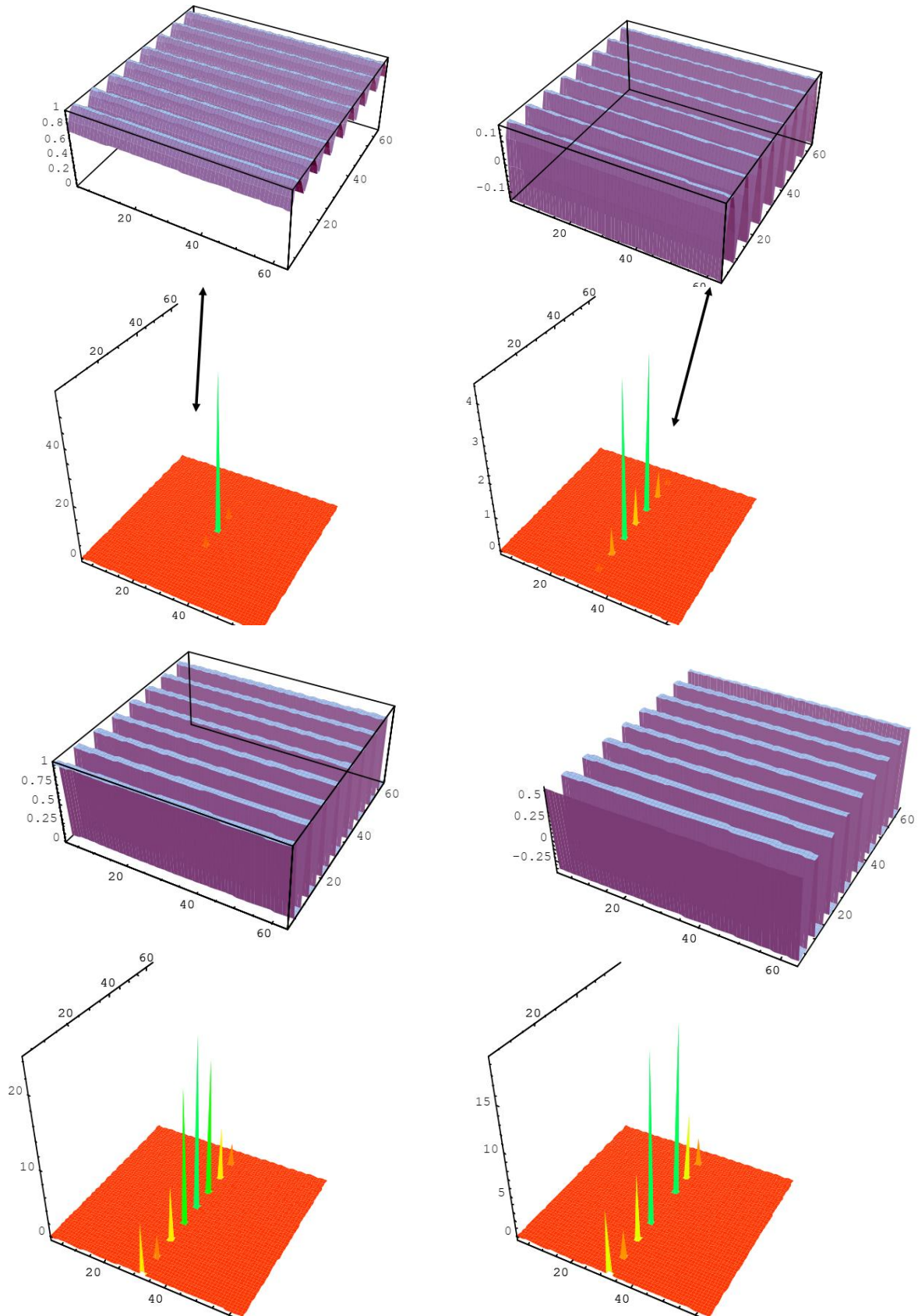

*Examples of Fourier transformations for lecture 6*